



# SIPHONS DE SOL INOX à panier CUVE CARRÉE

## Série 200



### ▶ Série C200

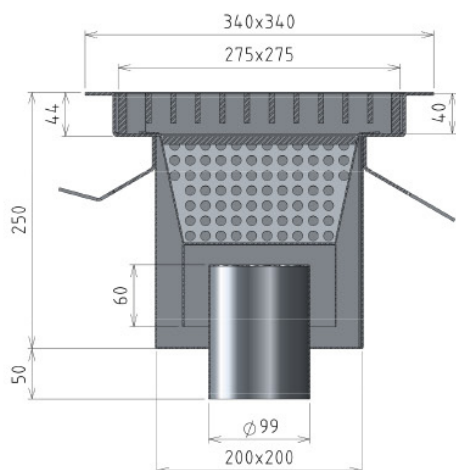







Les siphons de sol inox à panier à cuve carrée de la série 200 sont utilisés pour l'évacuation des déchets solides.

Débit	120 L/min
Diamètre évacuation	Ø 99 mm
Garde d'eau	60 mm
Capacité panier	2 L
Types de localisation	Abattoirs, salles de découpe...

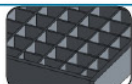
### ▶ Modèles disponibles

			Charge Impact	Références des siphons
Siphon standard Grille à barreaudage		G1	850 daN Ø150 mm	Réf. C200G1

### Autres siphons disponibles

Siphon grille caillebotis		G2	150 daN Ø150mm	Réf. C200G2
Siphon grille tôle pliée		G3	250 daN Ø150mm	Réf. C200G3
Siphon grille polyester		G4	150 daN Ø150mm	Réf. C200G4
Siphon grille gros débit		G5	900 daN Ø150mm	Réf. C200G5
Siphon grille fort passage		G6	1300 daN Ø150mm	Réf. C200G6
Siphon grille anti-dérapante		G7	850 daN Ø150mm	Réf. C200G7

### ▶ Options



Evacuation sécurisée

E+



Fabrication inox 316L